

High Power Targetry for Future Accelerators

September 8-12, 2003

Ronkonkoma, NY

Carrying ESS Forward – R&D on High Power Targets in the EU-FP6

Günter S. Bauer

Forschungszentrum Jülich, Germany

g.bauer@fz-juelich.de

ESS – A 2x5 MW Spallation Source Project

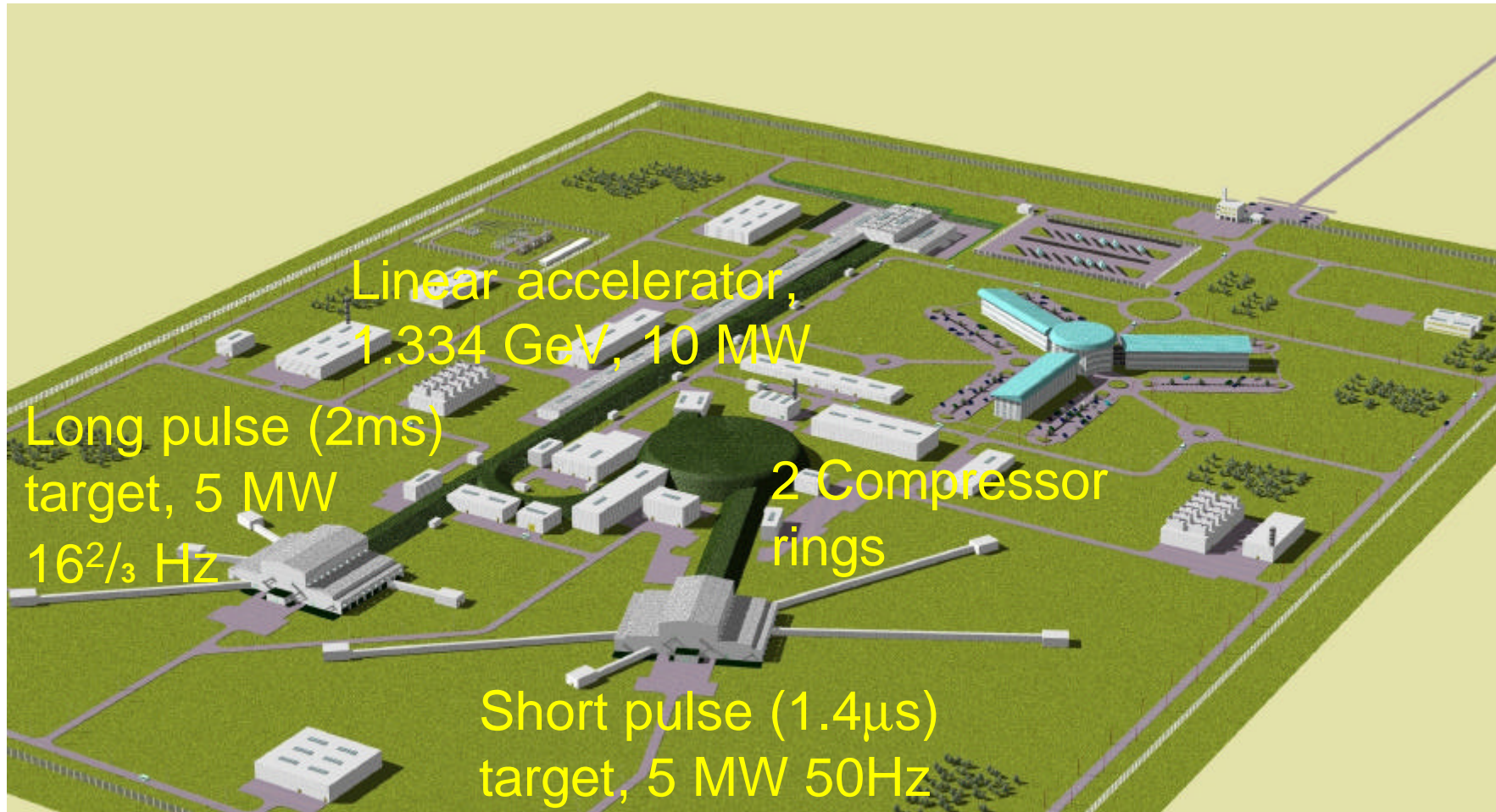

Long and Short Pulse Target Parameters

Two target stations

Beam power

Energy of protons

Time structure of proton pulse

Energy content of proton pulses

Repetition rate

Proton beam footprint at target

Target type

Injection

Number of moderators (viewed faces)

Average thermal flux

Peak thermal neutron flux

Effective decay time of flux

SP, Short Pulse

5 MW

1.334 GeV

2 x 0.6 μ s

100 kJ

50 Hz

6 x 20 cm²

flowing mercury

horizontal

2 (4)

3.1×10^{14} n/cm²s

1.3×10^{17} n/cm²s

150 μ s

LP, Long Pulse

5 MW

1.334 GeV

2.0 ms

300 kJ

16 ²/₃ Hz

6 x 20 cm²

flowing mercury

horizontal

2 (4)

3.1×10^{14} n/cm²s

1.0×10^{16} n/cm²s

150 μ s

Required accelerator pulse sequence

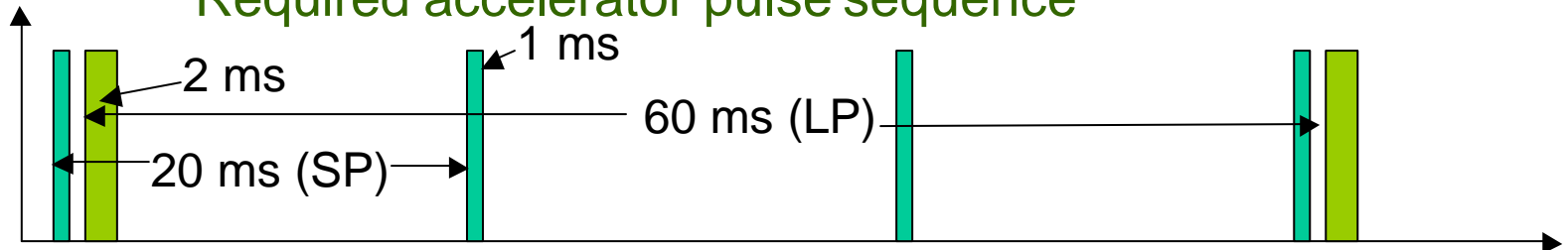

Proposed ESS Schedule

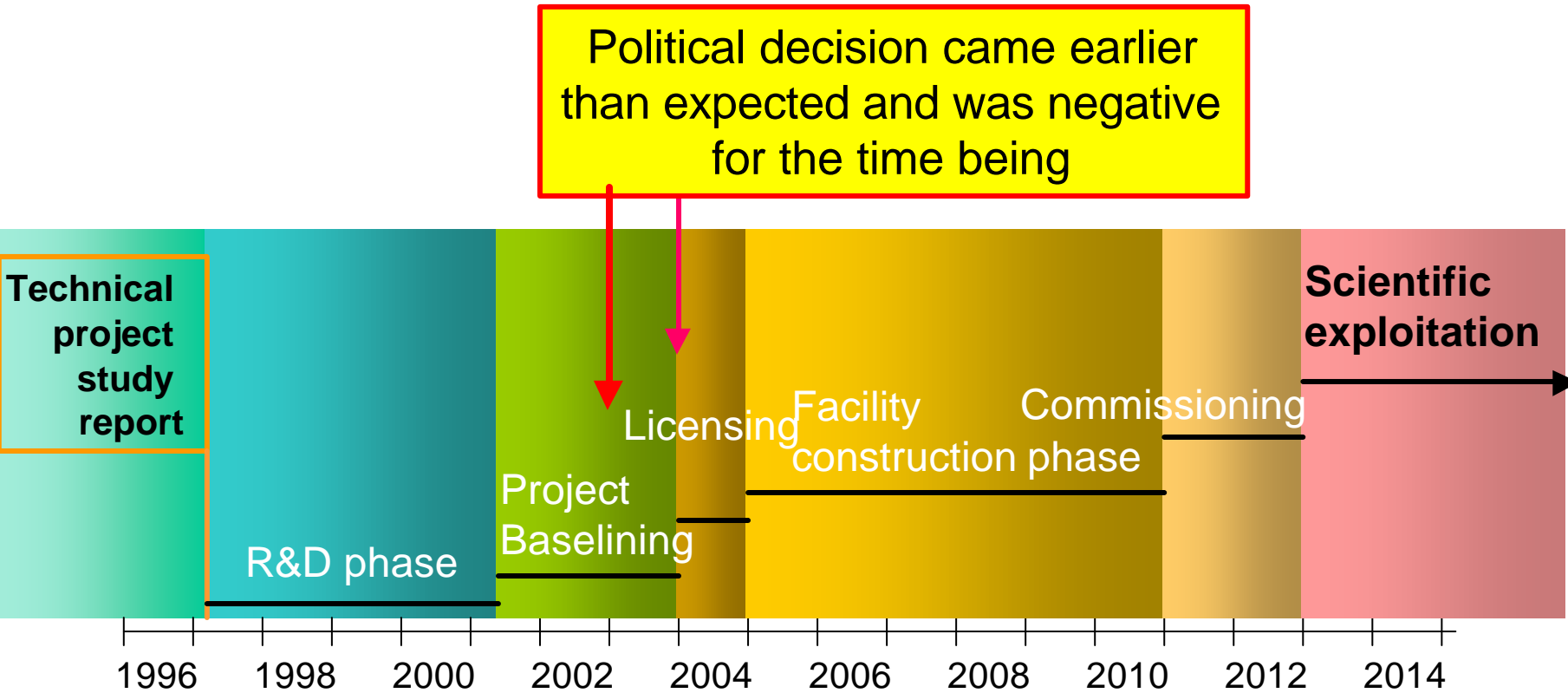

Political decision came earlier than expected and was negative for the time being

Technical project study report

R&D phase

Project Baseline

Licensing

Facility construction phase

Commissioning

Scientific exploitation

1996 1998 2000 2002 2004 2006 2008 2010 2012 2014

May 16, 2002 Bonn

Presentation of ESS reference concept to politicians, media and the general public with very positive response

ESFRI – Conclusions (Jan. 2003)

Despite a very positive assessment of the full ESS concept by its Neutron Sources Working Group, ESFRI's conclusions were

“Having examined and discussed the report of the Working Group on Neutron Sources (WGNS), the European Strategy Forum on Research Infrastructures (ESFRI):

(a) notes that there exists a “baseline” option, which has potential for growth through a series of plans for facility upgrades, to support scientific activities in the medium term;

(b) understands that there is not sufficient support from among the Member States for the realization of a next generation European Spallation Source in the short term;

(c) recognizes that a major new European neutron facility is necessary in the long term, therefore a decision is necessary in the medium term.”

Situation in Europe outside Germany

- France (CEA) withdrew from the Collaboration in 2002.
- UK has just approved construction of a 2nd target station for ISIS (60 kW). She sees a high power neutron source in Europe as a medium term necessity, in accordance with the ESFRI statement.
- Yorkshire („White Rose“) still maintains bid to host ESS.
- The Scandinavian Consortium offered a financial contribution which is too low to trigger negotiations with other potential partners.
- No strong position from any other countries.
- A major neutron research facility is operated jointly at the Institut Laue Langevin (ILL) in Grenoble.

The Situation in Germany

- Three operating research reactors for neutron scattering;
- In an assessment by the Science Council the scientific case for ESS was rated as not convincing, thereby overruling the findings of the relevant expert subgroup who rated it as very strong;
- In a later statement the Science Council clarified that they would never recommend a project for realisation, which did not have a defined host site (!!);
- The Sachsen and Sachsen-Anhalt consortium is still determined to fight for ESS, possibly funded through different channels than BMBF;
- The newly constructed research reactor FRM-2 was recently granted its final operating license (spring 2003).

ESS Outlook - FZJ

- Formal decision to terminate ESS-Project at FZJ by Dec. 31, 2003 was taken by FZJ-Directors on April 8. Needs to be approved by Scientific-Technical Council (WTR) and Supervisory Board (AR).
- 2003 ESS **funds in FZJ have been reduced** and relocated to the responsibility of the local Project Leader to ensure orderly closure of technical project activities.
- FZJ continues to be determined to strengthen its position as a stronghold for neutron scattering in Germany, among others by seeking to extend the service life of its FRJ-2.
- Critical R&D work for *source enhancement* is very likely to be supported in the out years under the new **Program Oriented Research Funding**.

Why do R&D on Source Enhancement?

- There were several issues in the ESS concept that needed to be resolved during the licensing and early construction phases. 
- A neutron source to be built in a decade from now will not be the same as proposed in 2002.
- Know-how and skills developed during the ESS study work must be preserved and transferred to a new generation of scientists and engineers.
- After the 2002 presentation several changes were introduced in the concept that would make ESS more flexible and of higher performance but needed more work.

Elevation of ESS Target Building

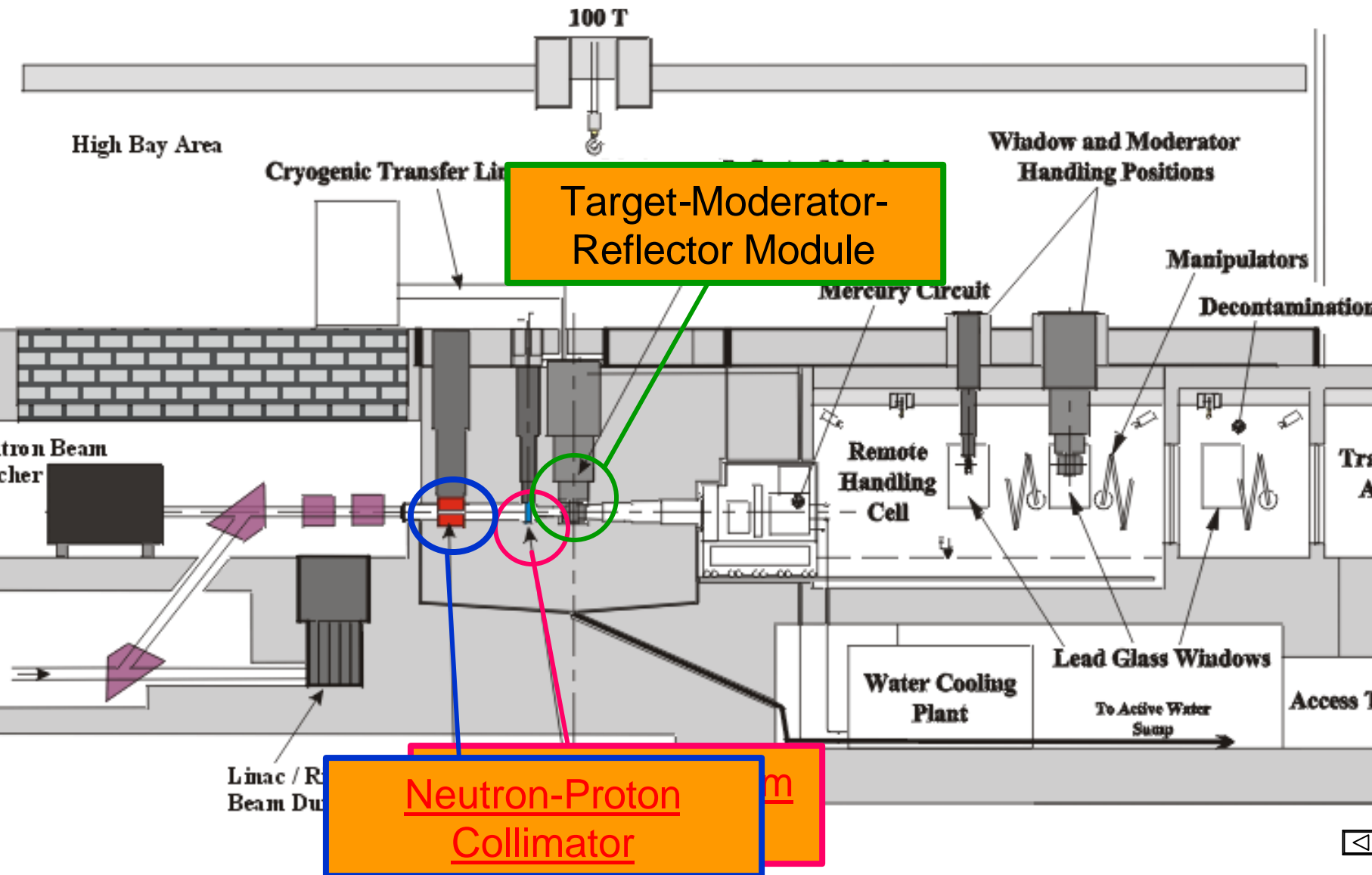

What Makes the ESS Concept Unique?

- A combination of long and short pulse target stations (optimum conditions for all instruments).
- A versatile concept of neutron beams and shutters (allowing large beam cross sections).
- A versatile target-moderator-reflector design (allowing, in principle also a rotating solid target).
- A flexible design of moderator systems (making possible also the use of advanced solid moderators).
- A novel pressure wave effects mitigation scheme (needed to run LMT at 5 MW SPTS and LPTS!).

Layout of ESS Beam Channels

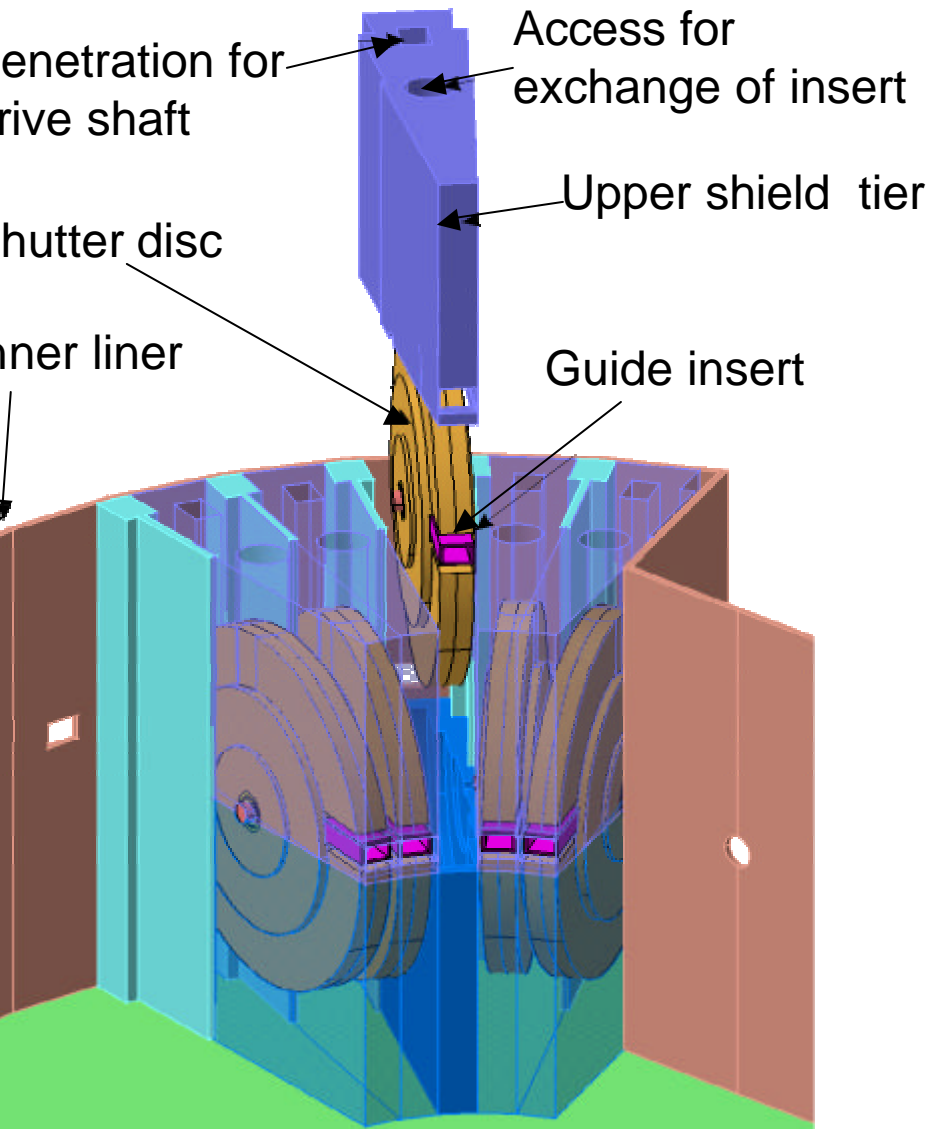

- ❖ Angular separation 11°
- ❖ Diameter of shutter disks 2.8 m
- ❖ Time to rotate shutter through 90° ca. 1 min
- ❖ Room for beam optics insert with $230 \times 170 \text{ mm}^2$ outer dimensions
- ❖ Exchange of shutter inserts from above while shutter is closed

Beam Optics Inserts

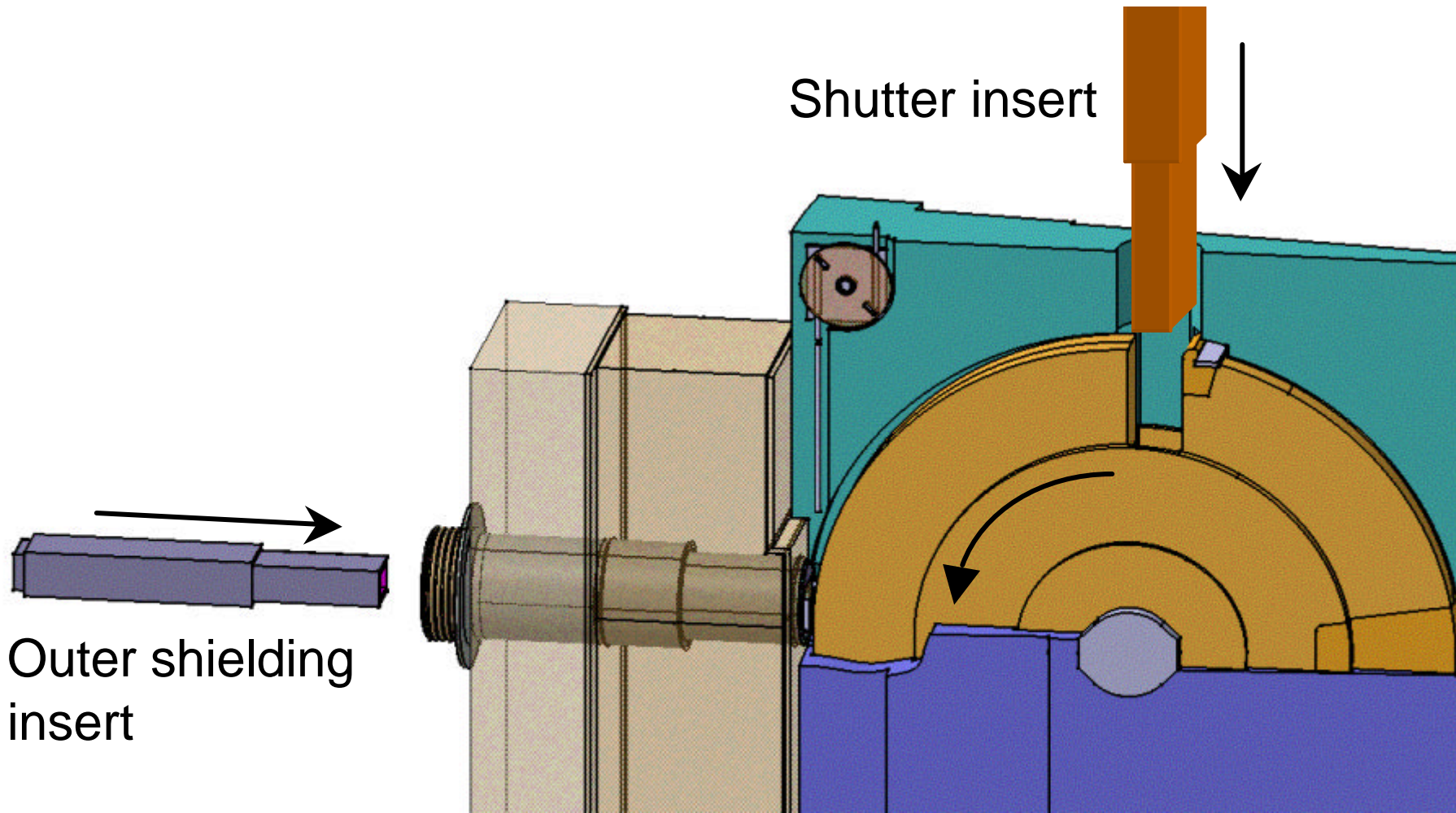

Inner Region of the ESS Target Block

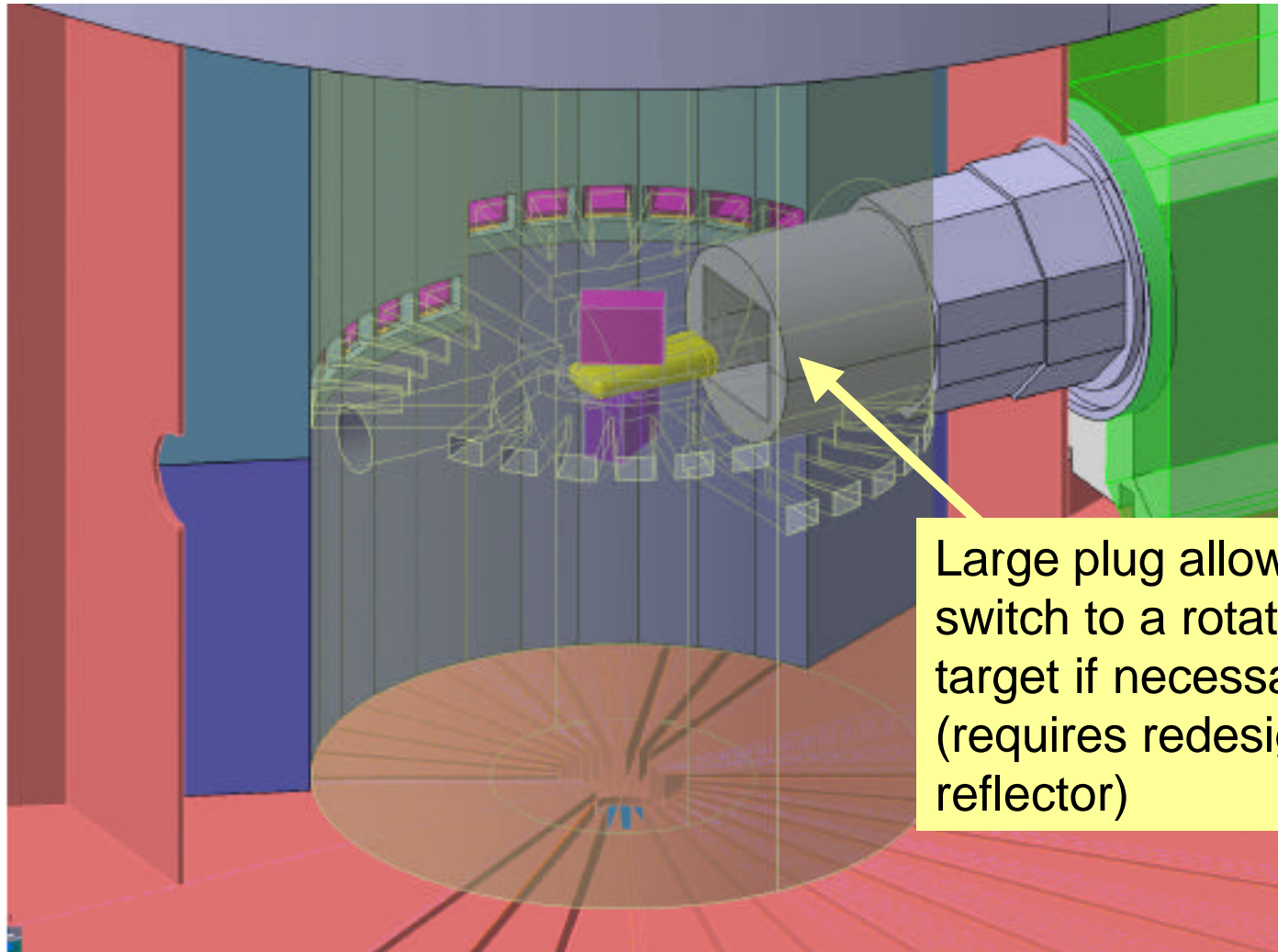

The ESS Target Moderator Arrangement

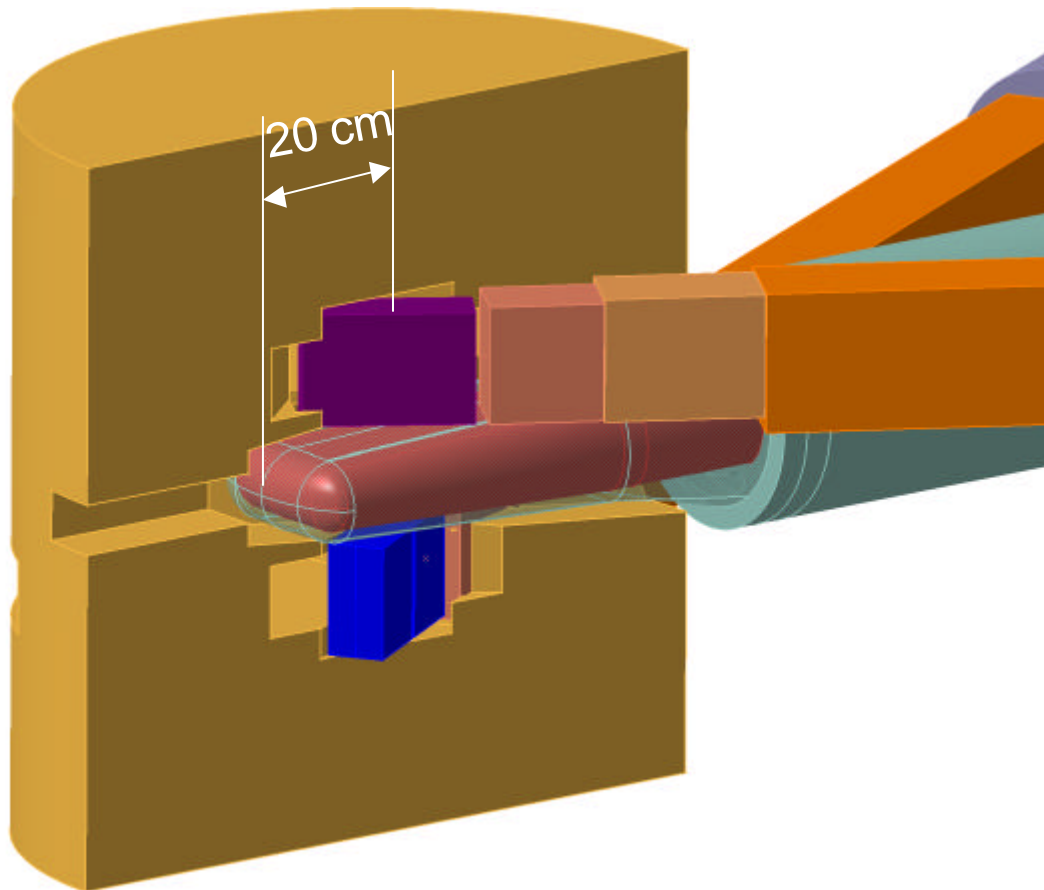

Optimum
Position of ESS
Moderators
Relative to
Target
(cf. „Vol 3“ 4-41)

To be
confirmed
for latest
moderator
concept



ESS Target Structural Modelling

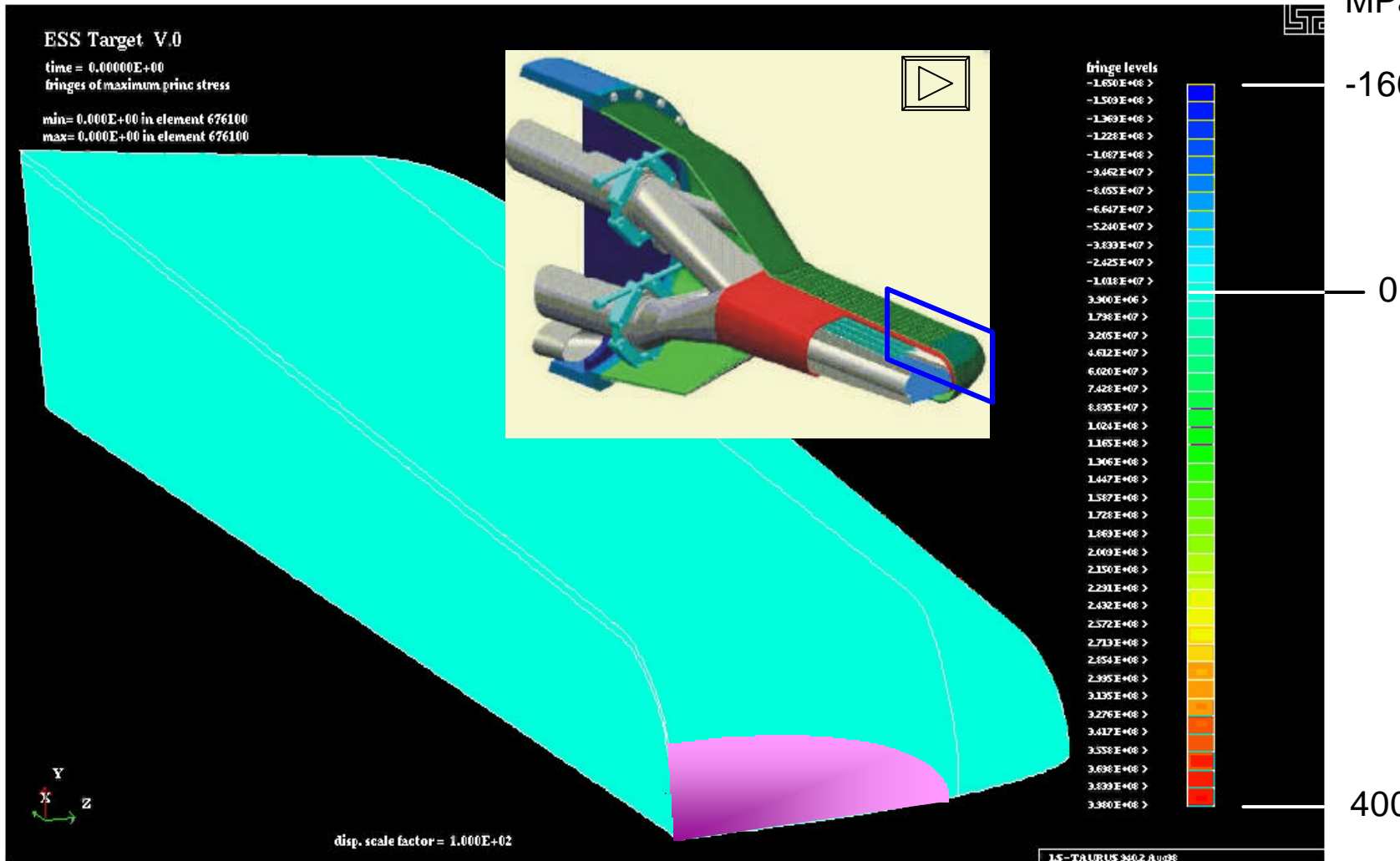

Optimizing the Target Geometry

Flow line tracing for different inlet flow distributions
(side duct / bottom duct / side duct):

39% / 22% / 39%

30% / 40% / 30%

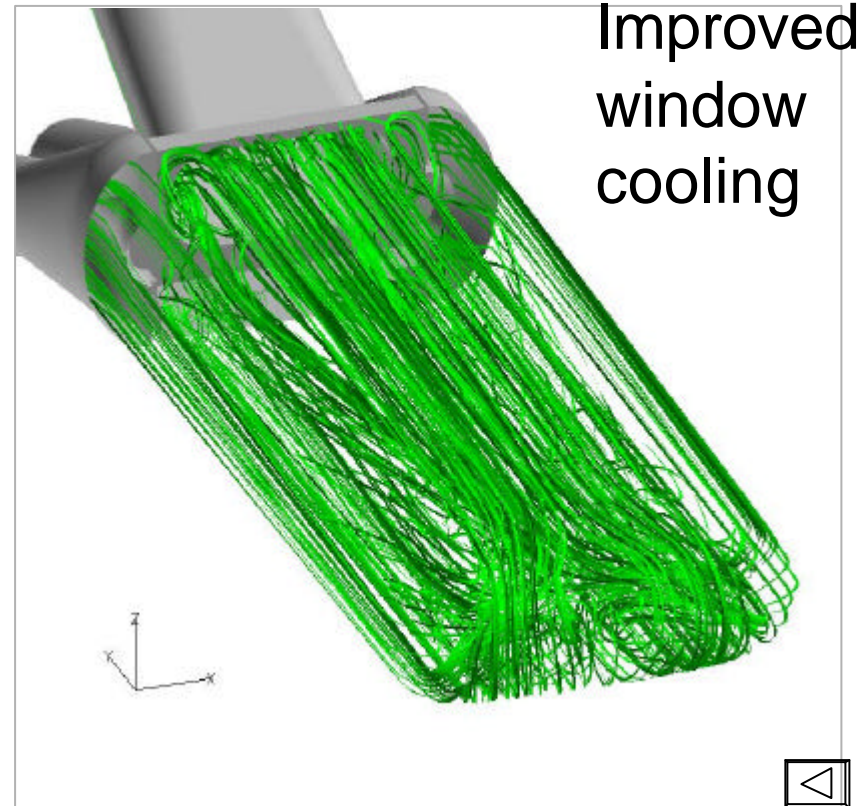
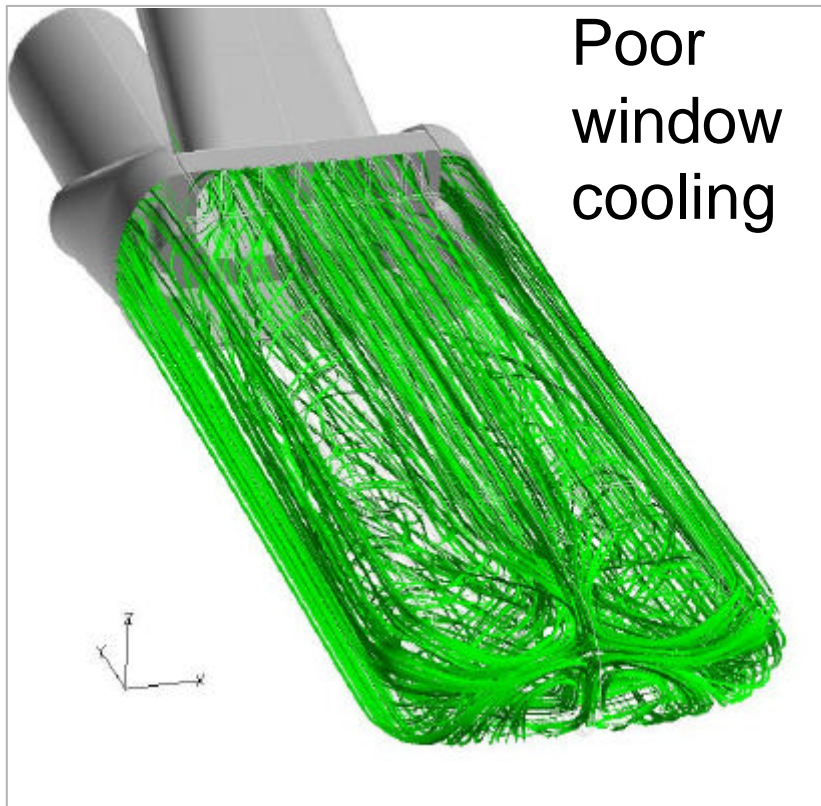

Effect of Pressure Waves in the Short Pulse Target

Stress distribution in Target for „elastic“ mercury

Deformations x 100!

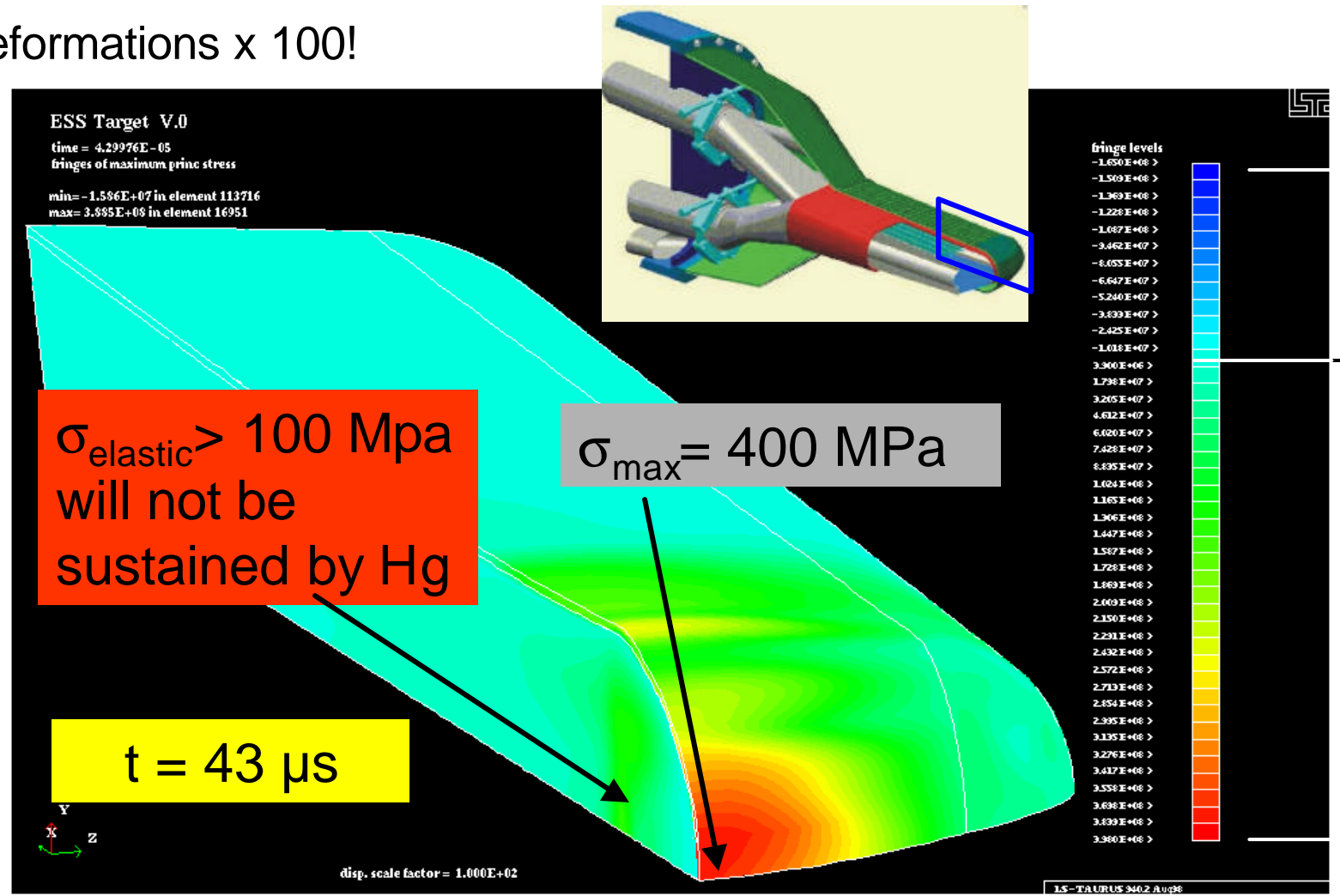

Pressure Wave Induced Liquid Metal-Wall Interaction

- Deformation of wall by pressure wave;
if unmitigated stress may exceed yield strength (SPT)
- Rarefaction with “negative” pressure (SPT and LPT)
- Cavitation of liquid under tensile stress
- Collapse of cavities near wall
- Liquid accelerated into collapsing cavity can damage wall
- First demonstrated for Hg-steel system at JAERI (Futakawa et al)
- Verified by in beam tests at WNR (Los Alamos)

Summary of earlier Pitting Erosion Tests

J. Haines and M. Futakawa

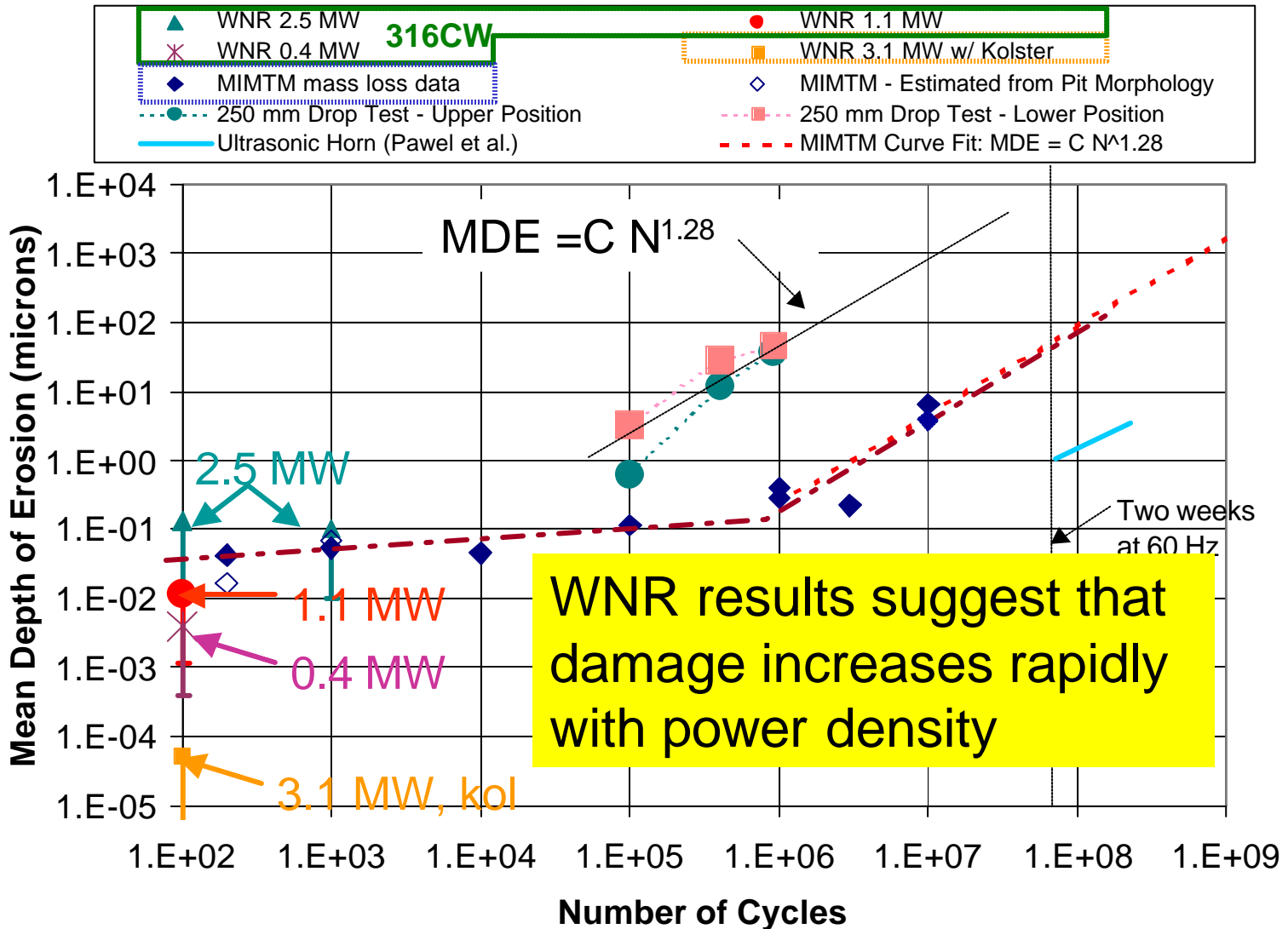

Correlation between area covered with pits and Mean Depth of Erosion

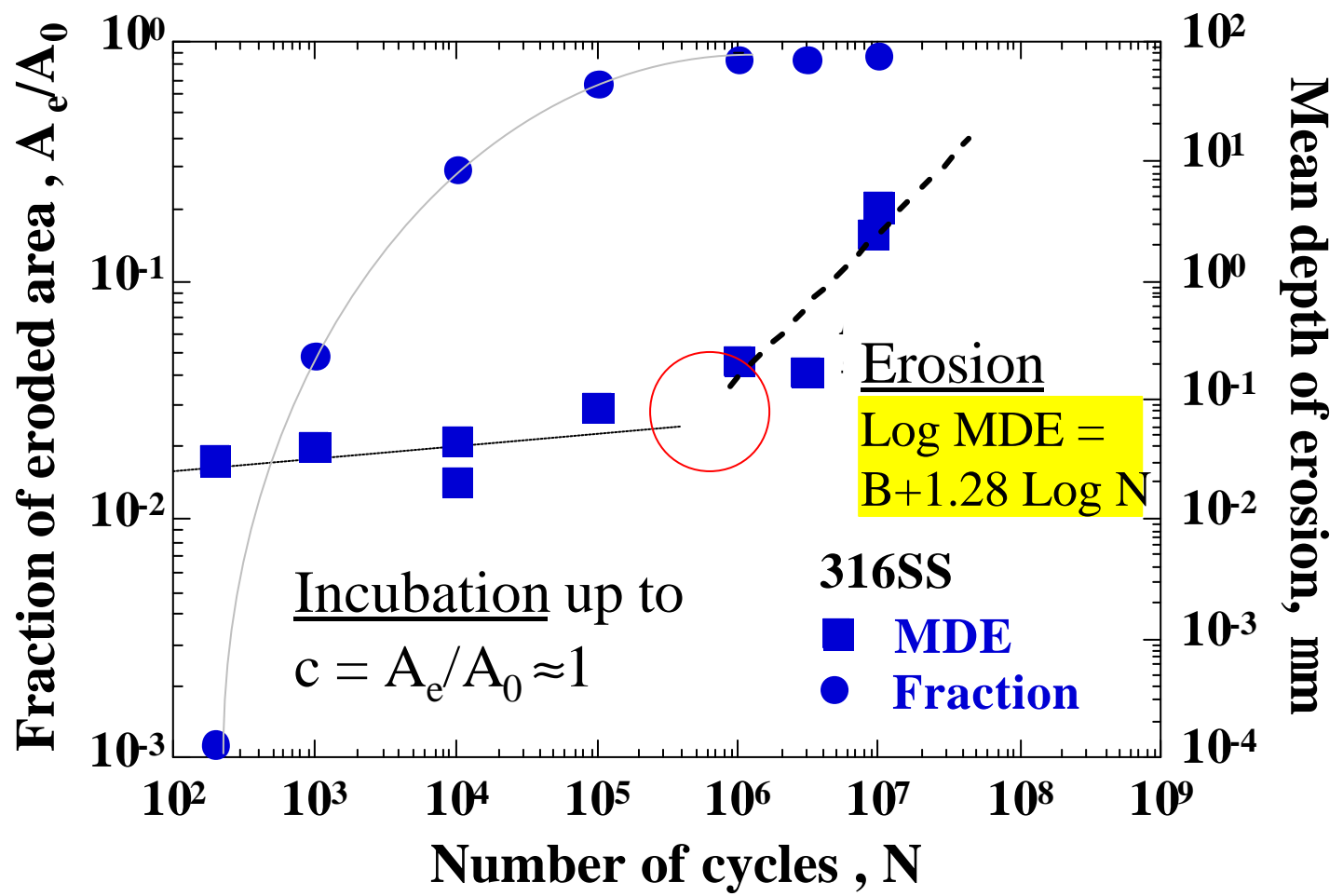

M. Futakawa, T. Naoe, C.C. Tsai, H. Kogawa, S. Ishikura, Y. Ikeda, H. Soyama, H. Date
 "Cavitation Erosion in Mercury Target of Spallation Neutron Source" paper GS-11-006
 5th International Symposium on Cavitation, Osaka, Japan, Nov. 1-4, 2003

Summary Diagram of Pitting Results

M. Futakawa
JAERI

*Kolsterising
can expand
incubation
period*

**New ORNL
results with
vibratory
horn even
suggest
smaller slope
($N^{0.77}$) for
Kolsterised
surface**

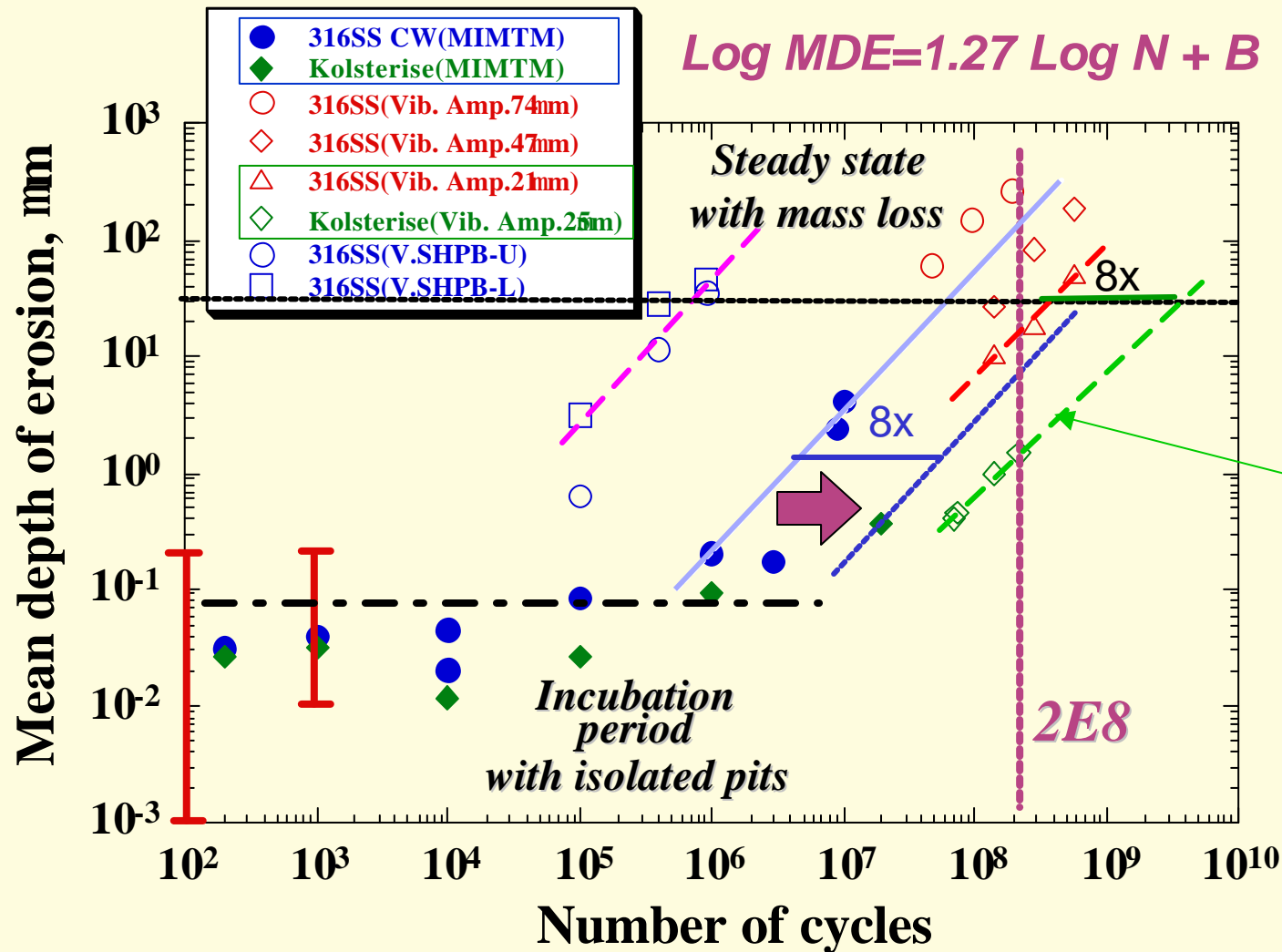

Number of cycles to reach end of incubation period ($c \approx 1$) for different power densities p and different surface treatments

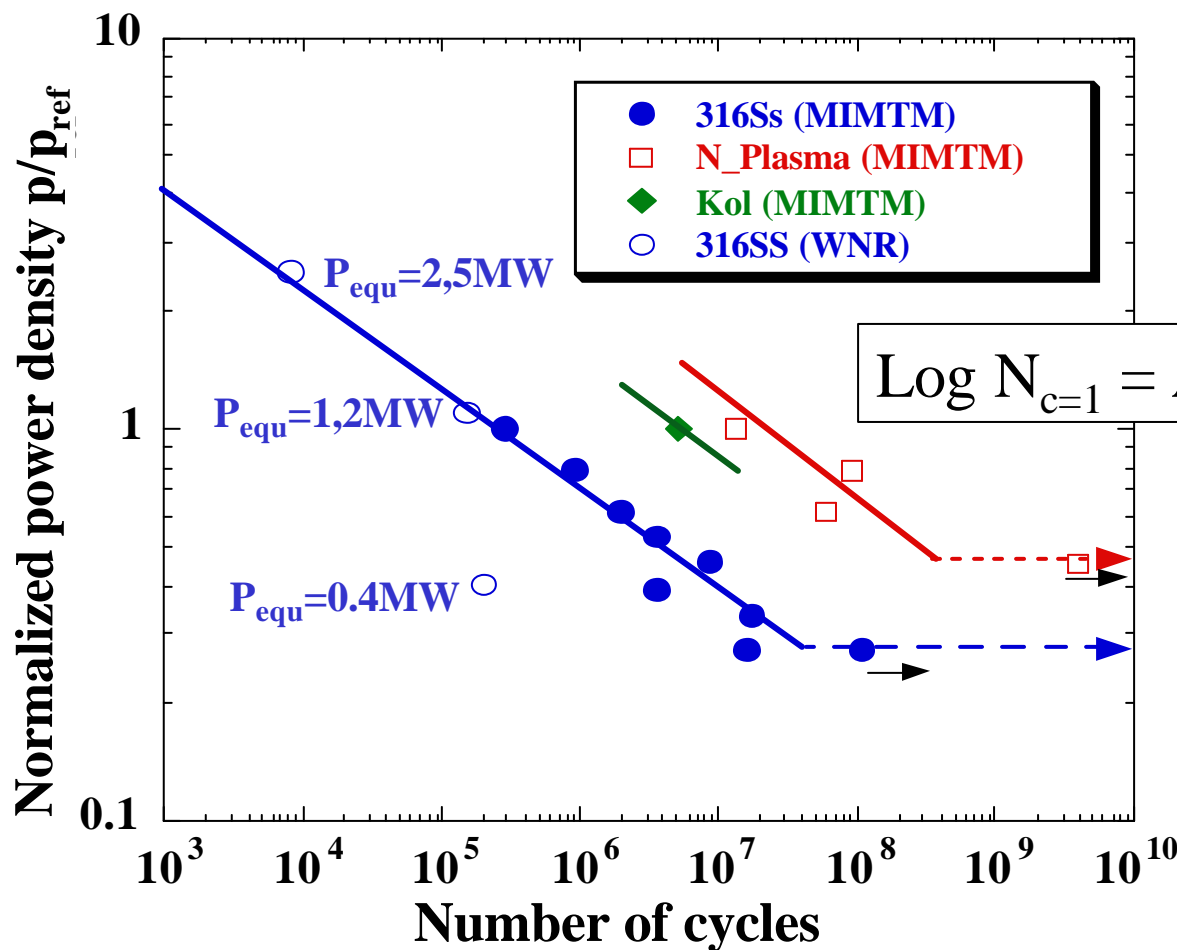

Pitting damage increases with the 4th power of power density!

A depends on material, pulse frequency etc.



P_{equ} is the power level in SNS that produces the power density used at WNR

M. Futakawa, T. Naoe, C.C. Tsai, H. Kogawa, S. Ishikura, Y. Ikeda, H. Soyama, H. Date
 "Cavitation Erosion in Mercury Target of Spallation Neutron Source" paper GS-11-006
 5th International Symposium on Cavitation, Osaka, Japan, Nov. 1-4, 2003

The emerging picture

- MIMTM-tests suggest that significant cavitation erosion (CE) starts, once the surface is fully covered with pits. 
- The number of pulses to the onset of CE in a given material depends inversely on the 4th power of the energy density in Hg.
- The MDE increases with the 1.28th power of the number of pulses (perhaps slower in implantation hardened surfaces):

Kolsterized (plasma nitrided) surfaces

- show a much smaller number of pits at comparable load levels
- Pits are much shallower than on CW 316 SS 
- Acoustic horn tests indicate smaller erosion rate at least within the hardened layer. 

Pitting degradation up to 10 million cycles

MIMTM plate specimen (Futakawa)

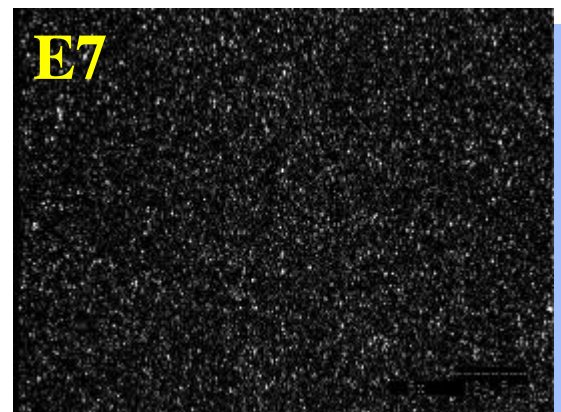
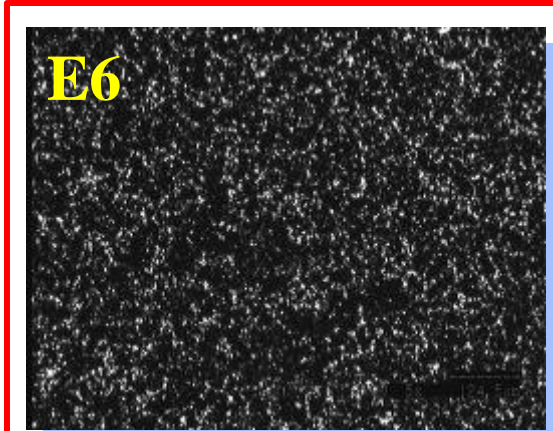
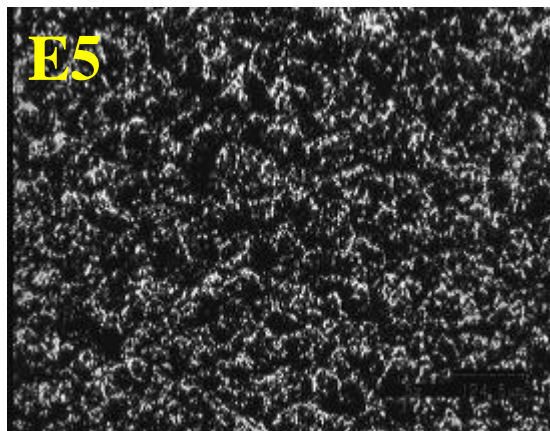
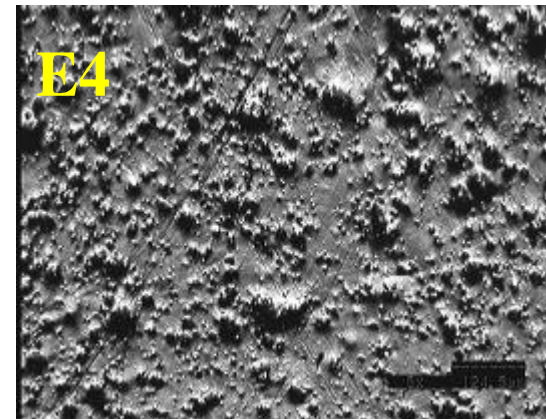
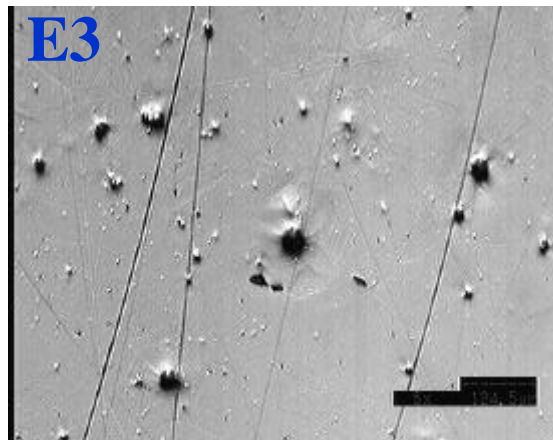
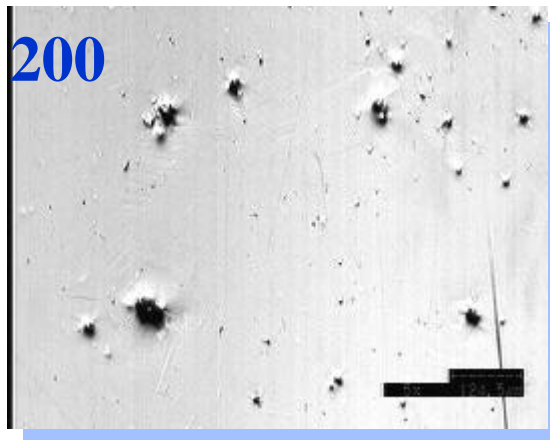

100mm



Depth profiles of pits in CW and Kolsterised 316SS

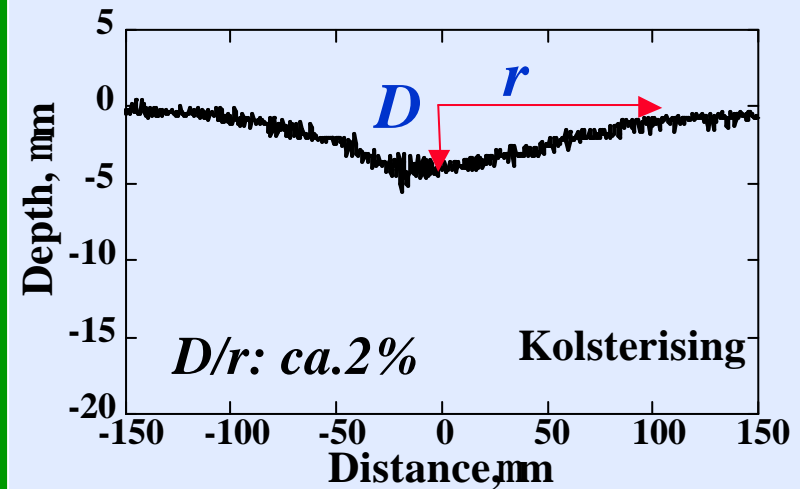
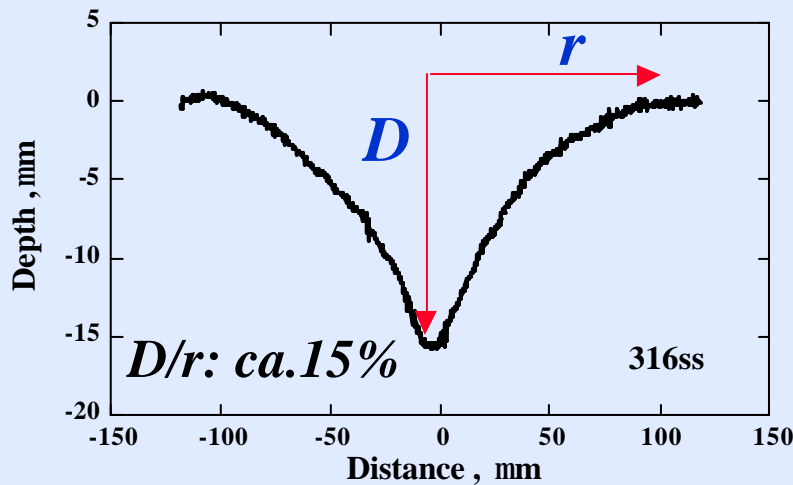
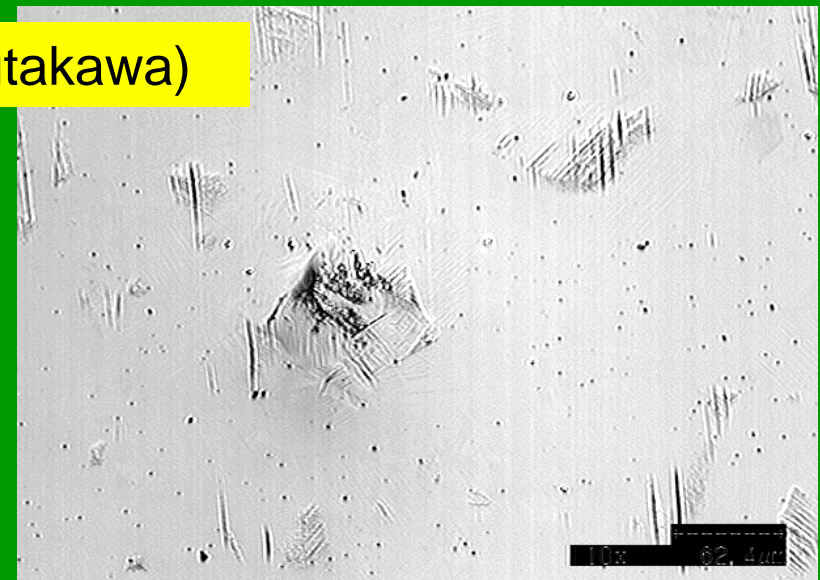
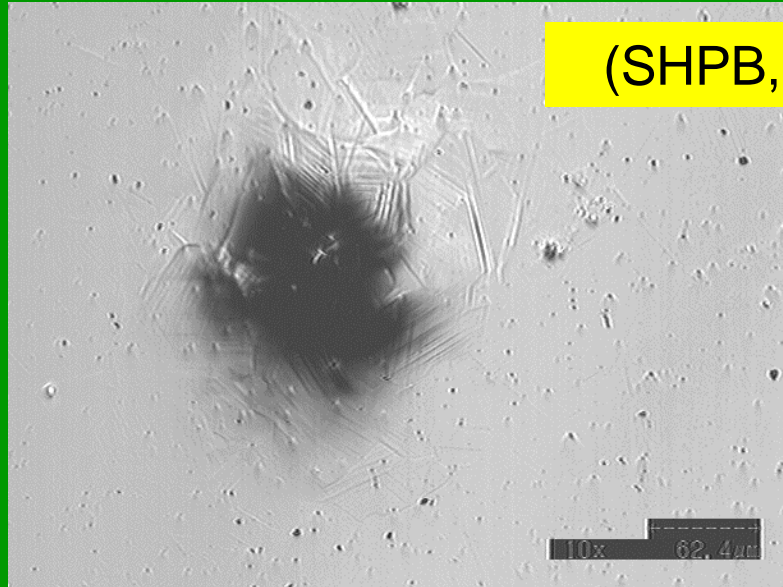

Important Questions

- Can Kolsterizing (or nitriding) be a near term method to obtain acceptable service life times of the target shell at intermediate power levels (1-2 MW)?
- How will the surfaces stand up to irradiation?
- What would be the level (limit) of confidence?
- On the long run we need a cure for the disease (pressure build-up), not for the symptoms

Target Container / Pitting Mitigation

Mitigation options

material

SHPB,
10 imp,
 $v_i=5.7\text{m/s}$

liquid

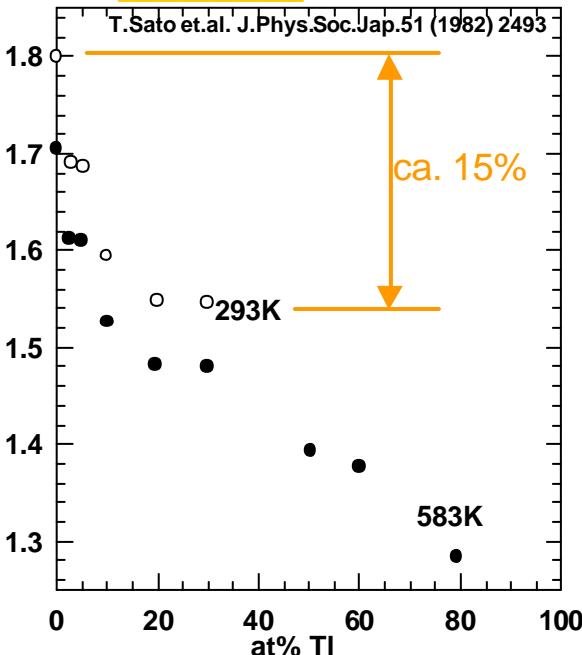
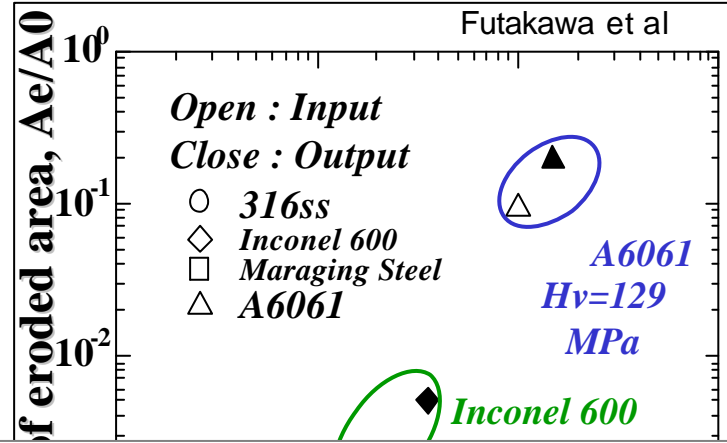

Thermal expansion coefficient in Hg-Tl mixtures

Non condensable gas-bubbles

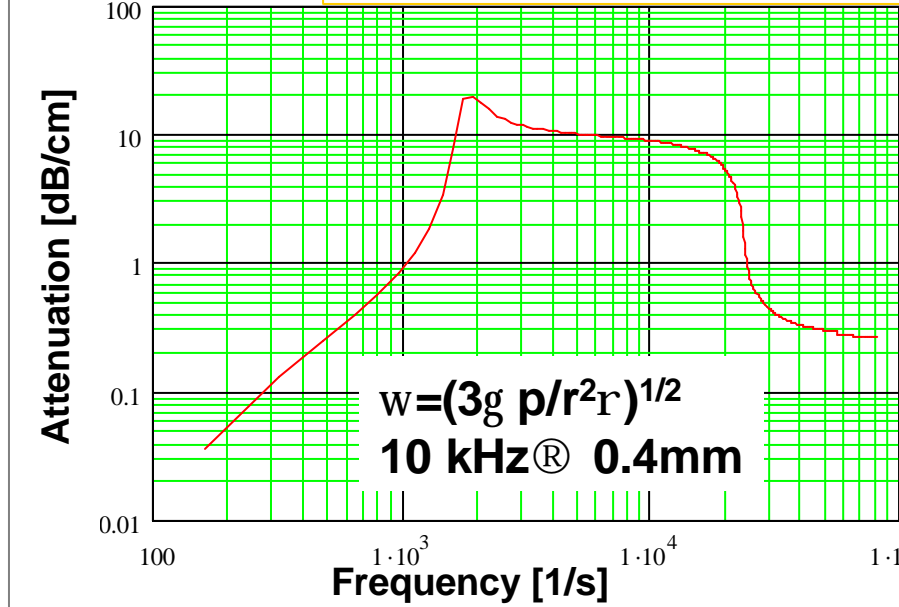

Attenuation of sound waves by a helium bubble ($r=1\text{mm}$, $DV/V=0.0377\%$) in mercury

Pressure Pulse Mitigation in Mercury

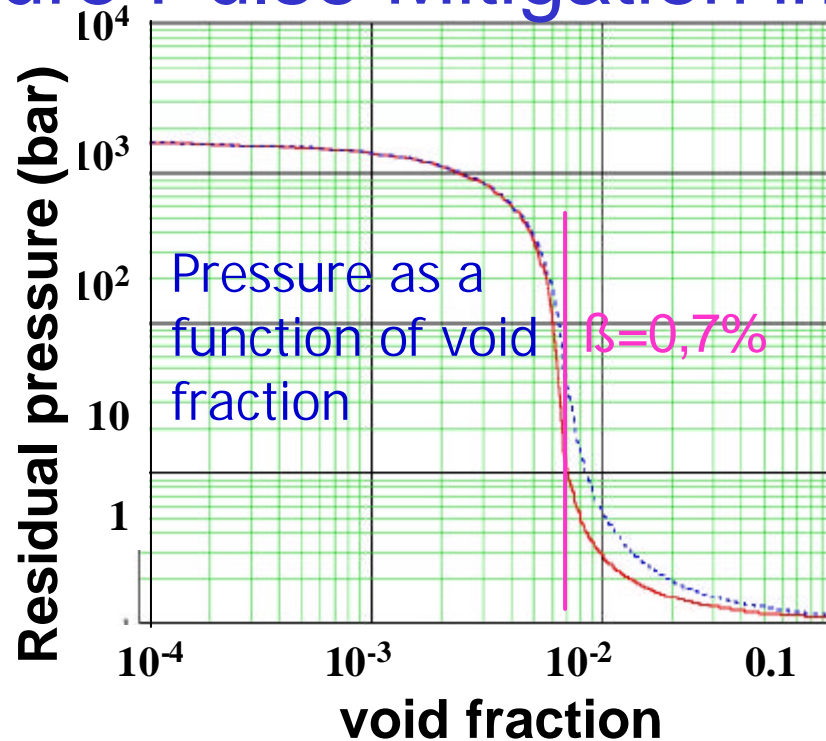

A volume fraction of ca1% of compressible gas bubbles with about 0.5 mm diameter are expected to reduce pressure buildup by nearly 3 orders of magnitude

Focus of research by the ESS team
in collaboration with SNS and JSNS

First PoP-test of Bubble Effect at WNR in June 2002

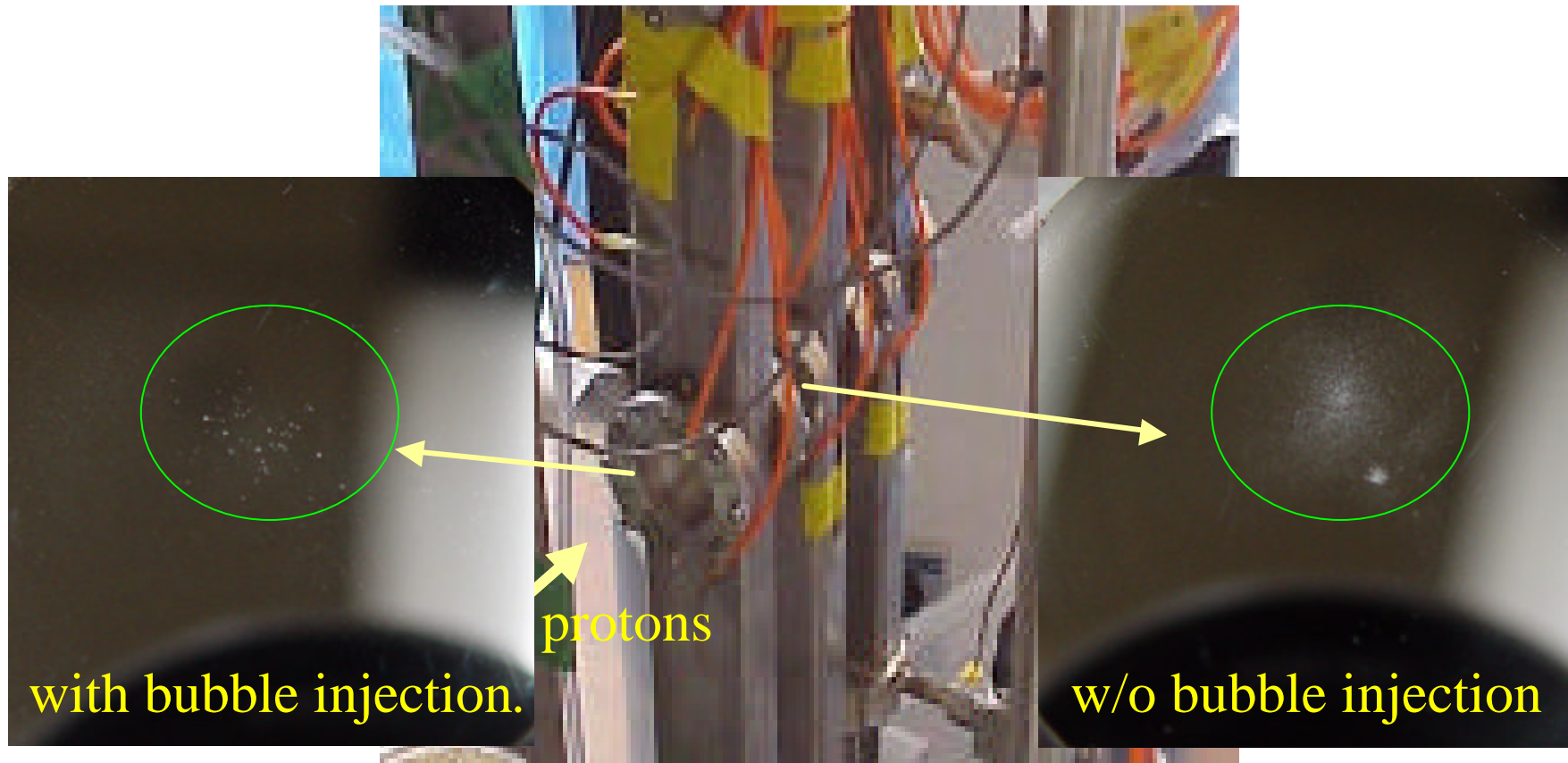

Maximum energy density in targets was 17.5 J/cc in bubble target and 14.4 J/cc in control target ($p^4 = 93789$ and 42998 respectively)

⇒ **Would expect more than twice the damage in bubble target**

⇒ **Find significantly less**

Current Status of Bubble Injection

- Four different nozzle systems built and tested successfully
- Acoustic Bubble Spectrometer to determine size distribution of bubbles tested successfully with mercury (and water)
- Installed in parallel bypass loops at the Riga mercury test facility
- So far not successful in making a sufficient number of small bubbles survive in the loop (10^{-5} rather than 10^{-2})
- Possible cause might be bubble interaction or thin pipes into which injection was attempted
- Similar problem observed in water

Topics for R&D on Source Enhancement

Advanced Moderators:

- **There is a prospect to improve long wavelength performance and flexibility of cryogenic moderators significantly by going to a heterogeneously cooled solid moderator material**
 - Coolability and radiation resistance of solid moderators
 - Manufacturing of suitable pellets
 - Transport and annealing
 - **Need demonstration of cryogenic system**

Targets:

- **To date there is no proven concept for a 5 MW pulsed target**
 - Cavitation erosion by pressure waves is an unresolved issue
 - There remain several materials problems to be investigated
 - Alternative options to the proposed concept need to be qualified
 - **Need a prototypic demonstration ready to go in a beam**



Preparations for FP6

- Intend to apply for a Design Study: **ADVICES**
“Advanced Design Validation and Innovative Concepts for a European Spallation Facility”

with three main topics:

- *Solid Cold Neutron Moderators at Very Low Temperatures*
(emphasis on pelletized methane hydrate)
- *Technology, Safety and Limits of Liquid Metal Targets*
(emphasis on Hg targets and their structural materials, including hazards and disposal)
- *Alternative Options for Source Drivers and Targets*
(emphasis on existing or planned accelerators and materials issues in solid targets)

Main Topics under Technology, Safety and Limits of Liquid Metal Targets

- Development of gas bubble technology: bubble injection, bubble transport, gas separator, gas treatment
- Development of in situ pressure wave simulation
- Target design – *operational aspects* (flow, gas injection, wall cooling, possibilities for damage annealing, etc.) 
- Target design – *safety aspects* (prevention of spills, hazard potential, recovery from leaks handling technique etc.)
- Spallation products in Hg – theoretical and experimental assessment of long lived hazardous isotopes, chemical reactions in the Hg (use existing irradiated Hg) 
- Alternative high strength wall materials (e.g. high Ni steels) – irradiation behaviour, high cycle rate fatigue, 

Effect of Irradiation on Tensile Properties

Results from examinations of components irradiated at LANSCE and ISIS (Ta)

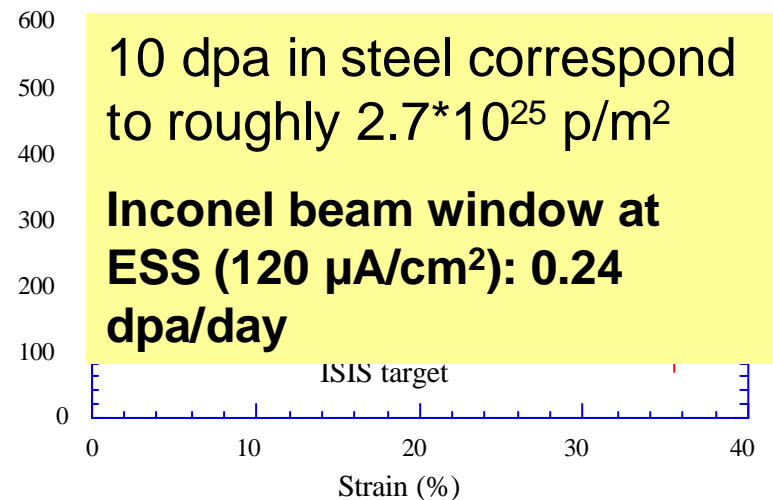
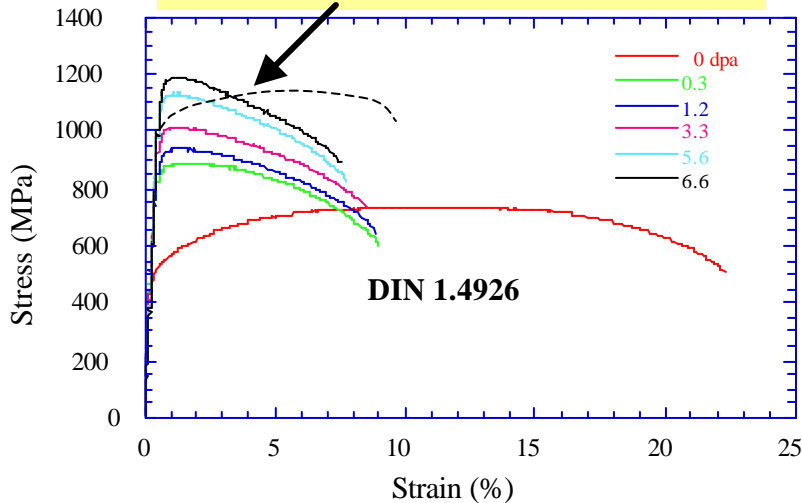
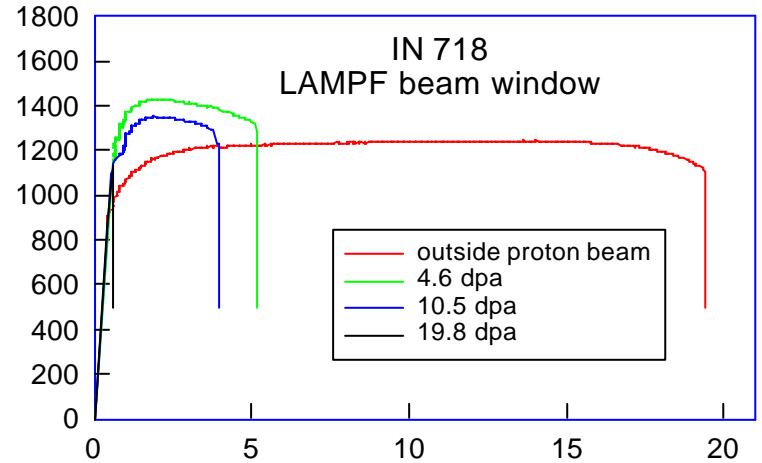
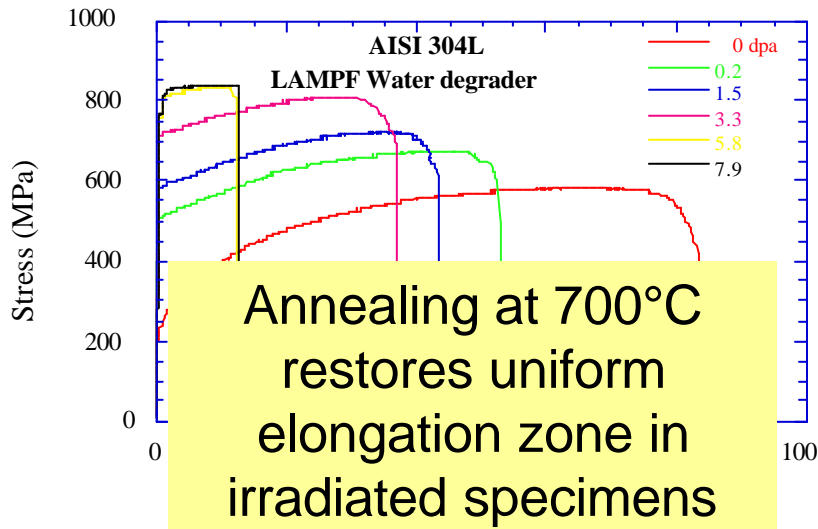

SINQ Irradiated Test Rod Containing Mercury

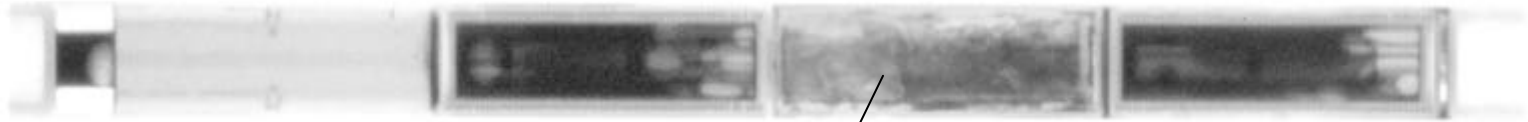

This capsule was corroded

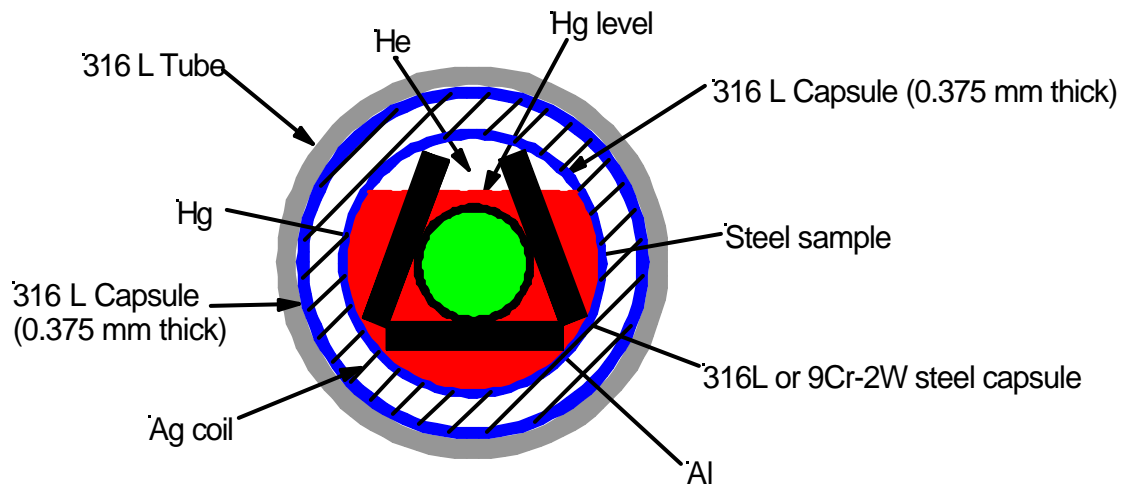
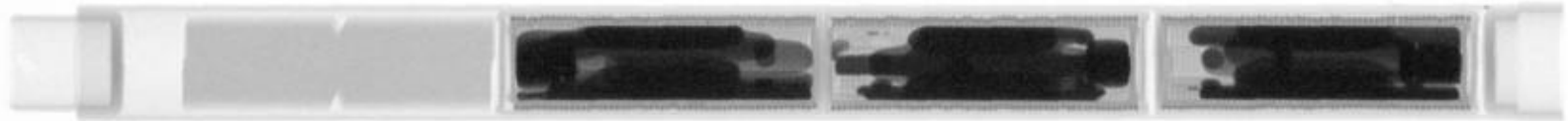

Target Rod A:

contains three Hg filled capsules (about 19 g in total) and one steel sample package. There is about 25% free space in each Hg filled capsule.



Effect of Pulsed Power Input on container

- Very high strain rate fatigue (MHz)

Frequency response of a cylindrical target shell measured at BNL (ASTE)

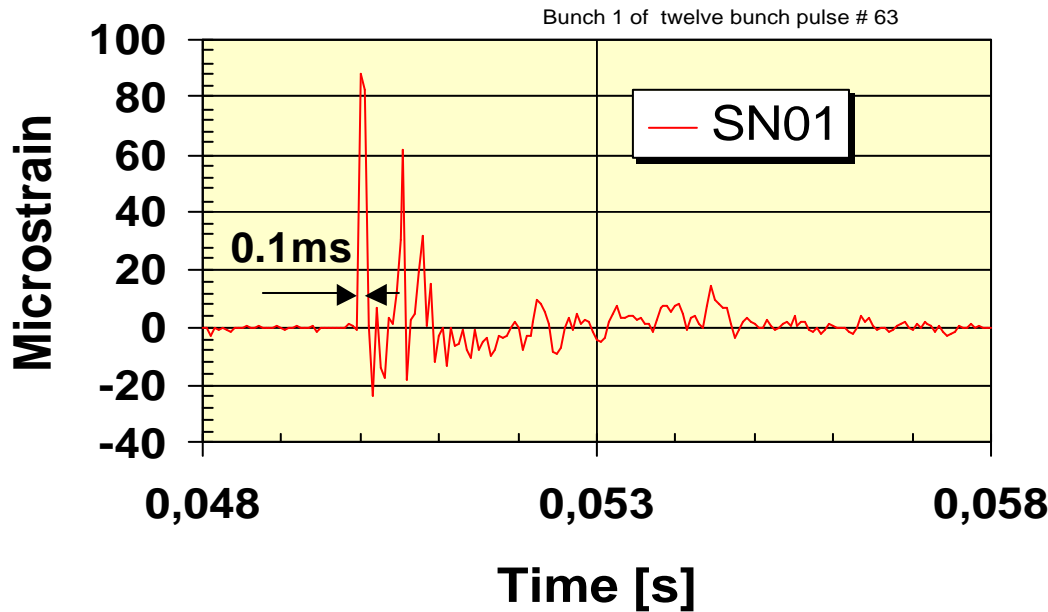

Very high frequency fatigue machine
(with piezo-crystal) under commissioning

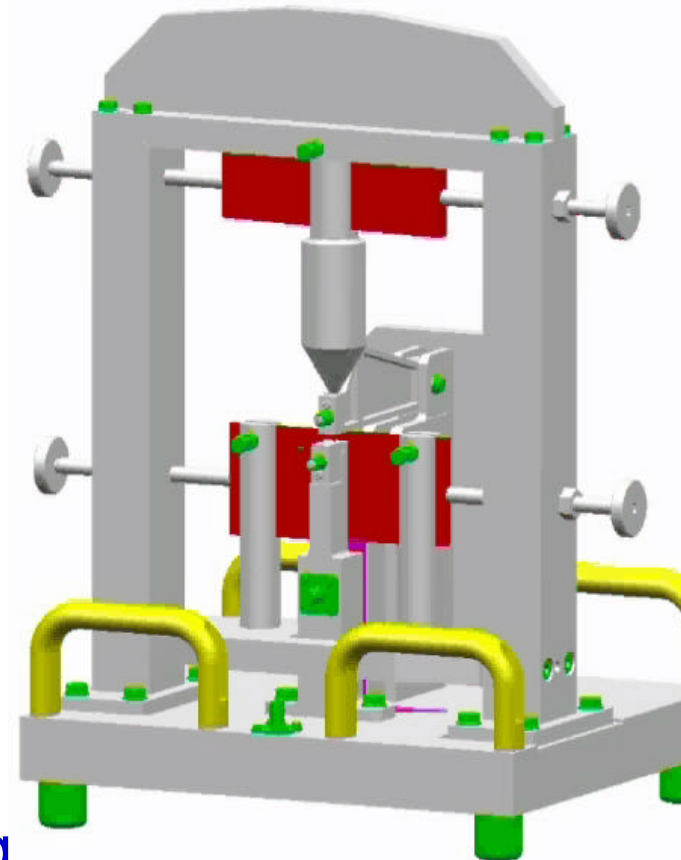

Status of the ADVICES Prorosal

- Call expected to be published in Nov 2003 with deadline for submission March 2004.
- Currently the task distribution and assignment of personnel by the participating parties is being negotiated.
- Held two preparatory meetings in Brussels and three topical workshops (Cracow, PSI and HMI).
- Next preparatory meeting on Sept 19 at FZJ.
- Work on agreement of collaboration with non-European partners (SNS, J-PARC, JINR)

Thank you for your attention!